

PHASE 1: HILLSLIDE

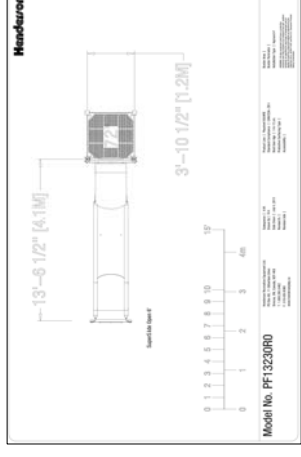

SERVICE ACCESS

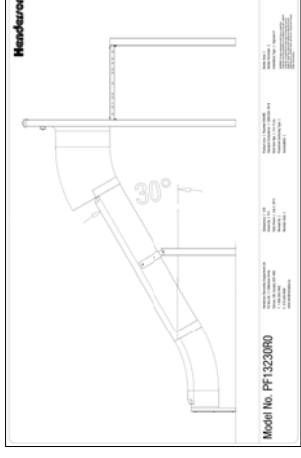
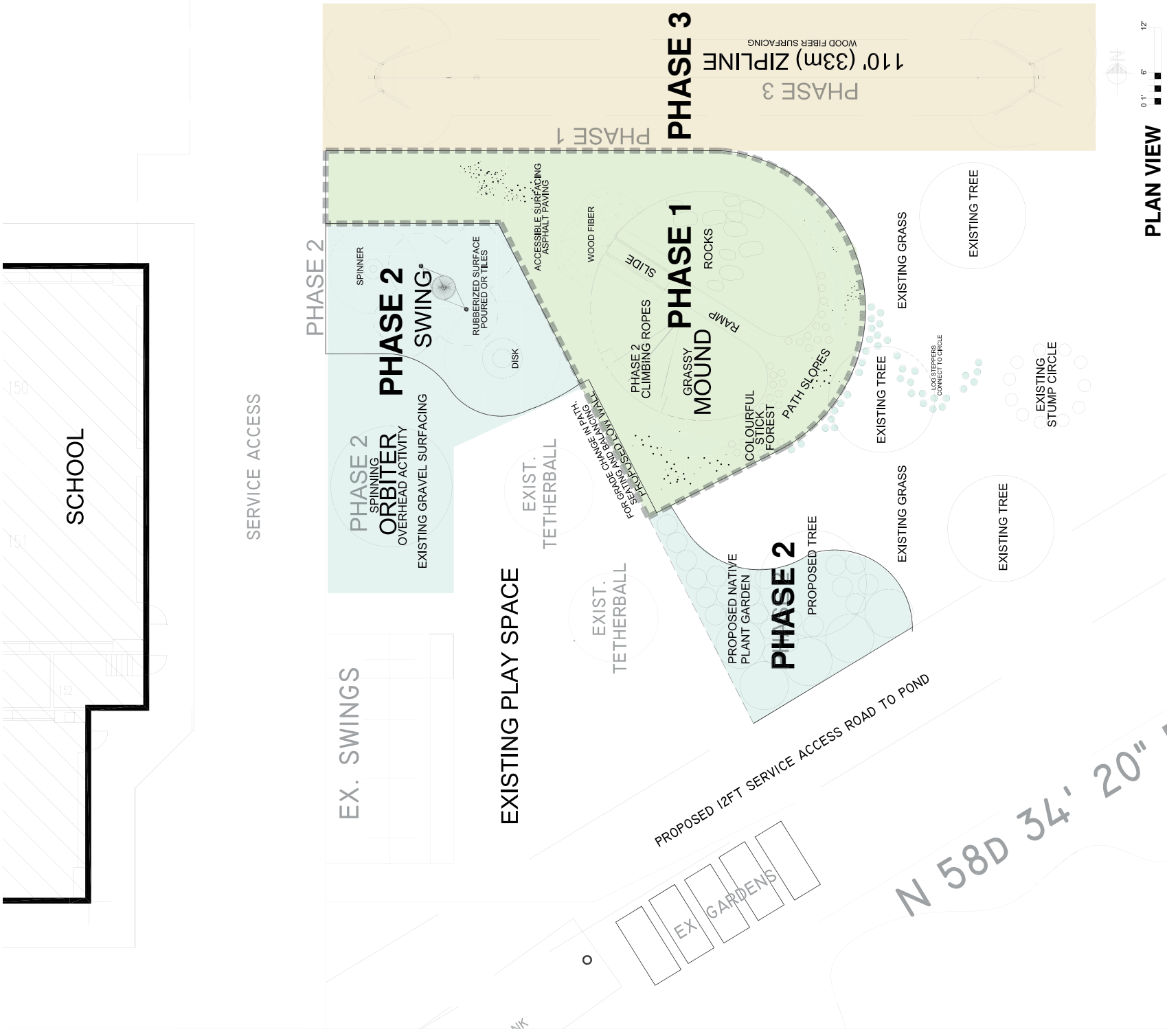

PHASE 2: FREESTANDING STAND-UP SPINNER

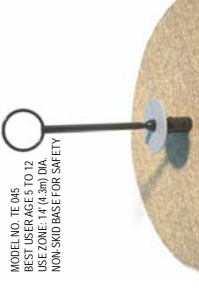

PHASE 2: FREESTANDING ORBITER



PHASE 2: COLOURFUL STICK FOREST EXAMPLES - CUSTOM FABRICATION



PHASE 2: SWING



PHASE 2: DISK

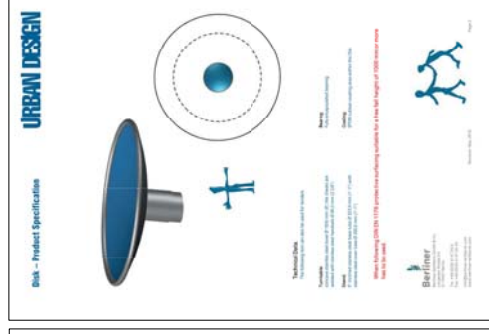

PHASE 3: ZIPLINE

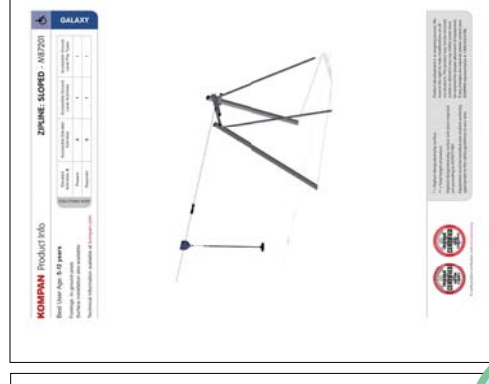
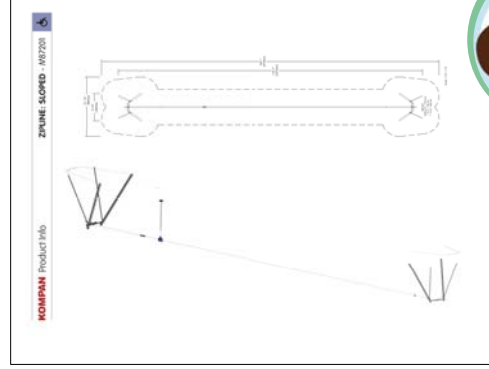

PHASE 3: CLIMBING ROPES FOR HILLSIDE



Phasing Ecole North Oyster School RECOMMENDED CONCEPT